

PUP40D-1WMC-1200 (102100970101)

Summary

PUP40D-1WMC-1200 is a constant current output mode LED driver. Support DALI dimming function, Touch DIM (Push DIM) function. The output and dimming circuit are also completely in accordance with the new regulations with isolation to ensure the users and luminaire system during installation.

Product Features

- Single channel output, output current level selectable by DIP S.W.
- Support DALI dimming function, Touch DIM (Push DIM) function
- Input voltage of 100VAC~240VAC
- Dimming range: 0.1-100%, Dimming effect smooth, no flicker
- Protections: Short circuit, Over load, Over voltage
- Suitable for indoor LED lighting application

Application

Technical Parameters

Model		PUP40D-1WMC-1200			
Input	Voltage	100VAC-240VAC			
	Frequency	50/60Hz			
	Efficiency	>87%@230VAC, Full load			
	PF	0.95@230VAC, Full load			
	THD(full load)	<10%@230VAC, Full load			
	Current	0.6Amax@100VAC			
	Inrush Current	Cold start,30A@230VAC			
	Standby Power	<1W			
Output	Current/Voltage/Power	850mA/9-42V/35.7W 900mA/9-42V/37.8W	950mA/9-42V/39.99W 1000mA/9-40V/40W	1050mA/9-38V/39.9W 1100mA/9-36V/39.6W	1150mA/9-34V/39.1W 1200mA/9-33V/39.6W
	Channel	1			
	No load output voltage	60V Max			
	Frequency	1KHz Min PWM			
	Current Accuracy	±5%			
	LF current ripple(<120Hz)	<3%			
Protection	Over Voltage	Hiccup, recovers after fault condition is removed			
	Over load	Hiccup, recovers after fault condition is removed			
	Short circuit	Close output, recovers automatically after fault removed			
Safety & EMC	Surge	L-N:1KV			
	Withstand Voltage	I/P-O/P: 3000VAC/1min/5mA			
	Safety standards	EN61347-1, EN61347-2-13			
	EMI Eission	EN50515,EN61000-3-2 Class C,IEC61000-3-3			
	EMC Immunity	EN61000-4-2, 3, 4, 5, 6, 8, 11; EN61547			
Function	Dimming type	DALI/Touch DIM (Push DIM)			
	Dimming range	0.1%-100% Dimming to off			
Others	Dimension	121*44*26.5mm(L*W*H)			
	Pack Information	Net weight: 156g±5%/PCS; 50PCS/Carton; 8.3kg±5%/Carton; Carton Size: 286x239x194mm(L*W*H)			
	IP rating	IP20			
	Working temp.	-20°C-50°C			
	tc	90°C			
	Relative humidity	20-90% RH			
	Lifetime	50,000h@tc:85°C			
	Warranty	5 Year			
	Material	PC			
Switch cycle	>25,000 times				

Remark: Use only within an enclosure

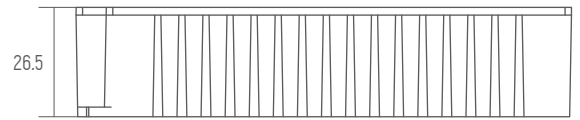
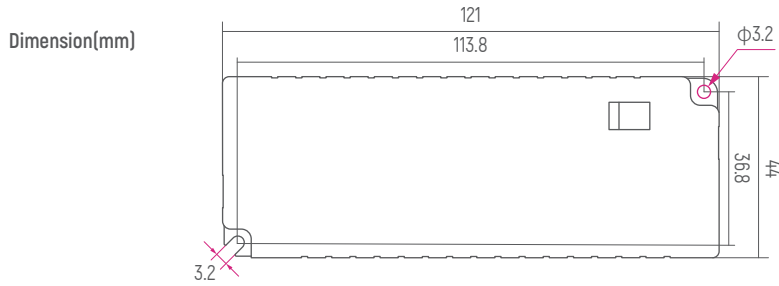

Wiring Diagram

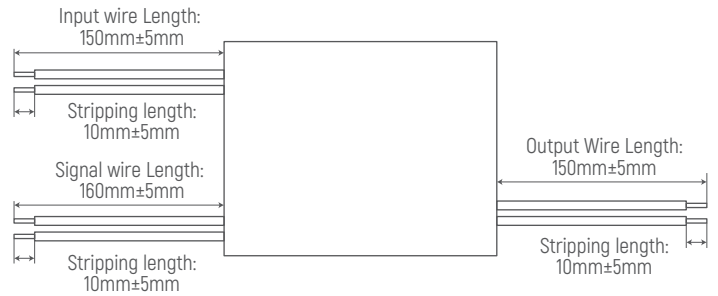
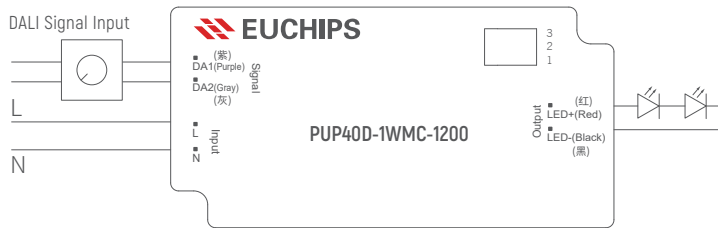

DALI Diagram

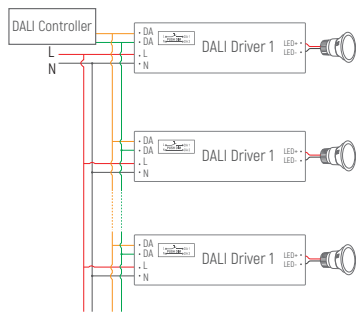

Touch DIM(Push DIM) Diagram

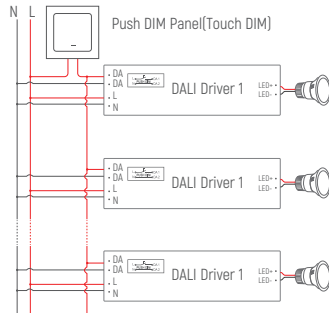

Remark: Only use open push button without indicator light. Maximum cable length between each Unit: 20 meters.

Dimming Curve

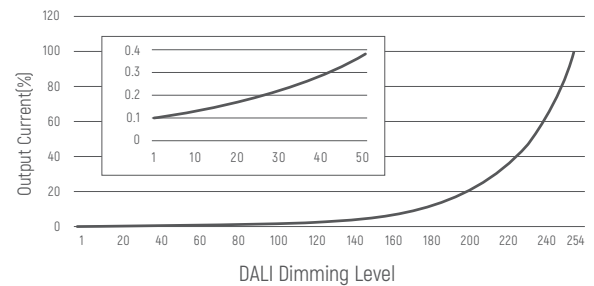

Push DIM Function

1. Press the Touch DIM (Push DIM) switch for 8s or more,the driver can be controlled via Push DIM switch.
2. Short press the Touch DIM (Push DIM) switch (<0.5s) to control the lamp on or off.
3. Long press the Touch DIM (Push DIM) switch (>0.5s) to dim the brightness of light. The dimming direction will change every time after pressing switch.
4. Double-click the Touch DIM (Push DIM) switch (<0.3s), then all lamps connected on the device will be set maximum brightness.
5. The brightness adjustment range is 1%-100%, and the light can be turned off through short pressing when doing the adjustment with long pressing Push DIM switch.
6. With the Power off memory function, the power-down state will be recovered when power on again.

Current Selection Table

PUP40D-1WMC-1200 is a multi-current dimming driver, output current level selectable by DIP S.W., as the following:

ON	OFF	1	2	3														
		850mA	900mA	950mA	1000mA	1050mA	1100mA	1050mA	1200mA									
		9-42V	9-42V	9-42V	9-40V	9-38V	9-36V	9-34V	9-33V									

Remark: Function default setting is: 850mA (@switch are all OFF state)

Cautions

- 1.This product should be installed by qualified personnel.
- 2.This product is non waterproof, need to avoid sun and rain.In case of outdoor use, please ensure it is mounted in a water proof enclosure.
- 3.Good heat dissipation conditions extend product life.Please install the product in a well-ventilated environment.
- 4.Please make sure LED power supply output voltage, current is used to meet the product requirements.
- 5.Please ensure that adequate sized cable is used from the controller to the LED lights to carry the current. Please also ensure that the cable is secured tightly in the connector.
- 6.Due to safety concerns, PVC or rubber cord of 0.75-2.5mm² is recommended for input and output terminal(s) (excluding signal terminals). Flat power cord is not suitable.Ensure all wire connections and polarities are correct before applying power to avoid any damages to the LED lights.
- 7.In case of malfunction, do not repair it yourself.